

Eco-POWER METER simplifies the management of the energy use for your facilities and machinery. New MEWTOCOL communications protocol function added for easy PLC connection.



RoHS Directive compatibility information
<http://www.nais-e.com/>

FEATURES

1. Electricity meter that acts like an industrial component (DIN size: 48×48)

Eco-POWER METER is both compact and inexpensively priced. It is easy to install on your existing equipment and machinery.

2. Digitally display integrated electrical energy and electricity charges

You can digitally display integrated electrical energy, voltage, current, and electricity charges. This is handy for managing energy-saving.

3. Log and track data of integrated electrical energy usage

It is easy to load the power usage pulse output into a PLC or counter.

4. Centrally manage integrated electrical energy, voltage, and current

Equipped standard with RS485 communication port. Up to 99 units can be connected (when using our recommended devices).

PRODUCT TYPES

Product name	Phase and wire system	Rated input	Current transformer	Terminal type	Part No.
KW4S Eco-POWER METER Main unit	Single-phase two-wire system Single-phase three-wire system Three-phase three-wire system	100 to 120/ 200 to 240V AC	Dedicated CT type*1	Screw terminal	AKW4111
			Commercial CT type**1*2	11-pins	AKW4211
Dedicated current transformer (CT)	Can be used with AKW4111 and AKW4211 (For KW4M Eco-POWER METER, AKW5111 and AKW5211.)			Screw terminal	AKW4121
			11-pins	AKW4221	
Data collection software for Eco-POWER METER	Setting of any parameter, and editing and monitoring of all measurement values. Downloadable from http://www.mew.co.jp/ac/e/download/index.html				KW Monitor

Notes:

*1. You can use the dedicated CT to measure primary current rated up to 50A. If the primary current is rated above 50A, please use a commercial CT in combination with the commercial CT type Eco-POWER METER.

*2. The commercial CT should have a secondary current rating of 1A.

DEDICATED CT AND COMMERCIAL CT

Dedicated Current Transformer (CT) (AKW4801) (option) Specifications

Item	Specifications
Rated primary current	50A
Ratio error	±1.0% F.S.
Diameter of conductor to be measured	10 dia. (max.)
Breakdown voltage (Initial value)	1,000 Vrms AC for 1min: Between core and output connector terminal
Insulation resistance (Initial value)	Min. 100MΩ: Between core and output terminal (at 500V DC)
Allowable number of detachments/attachments	Approx. 100 times
Vibration resistance (Functional)	10 to 55 Hz: 1 cycle/ min single amplitude of 0.15 mm .006 inch (10 min on 3 axes)
Vibration resistance (Destructive)	10 to 55 Hz: 1 cycle/ min single amplitude of 0.375 mm .015 inch (1 h on 3 axes)
Shock resistance (Functional)	Min. 98 m 321.522 ft./s ² (4 times on 3 axes)
Shock resistance (Destructive)	Min. 294 m 964.567 ft./s ² (5 times on 3 axes)
Operating temperature range	-10°C to +50°C +14°F to 122°F (Without frost and non-condensing)
Storage temperature	-30°C to +60°C -22°F to 140°F (Without frost and non-condensing)
Mass (Weight)	Approx. 50g 1.76oz (Trunk cable included)
Ambient humidity	35 to 80% R.H. (non-condensing at 20°C)

Dimensions

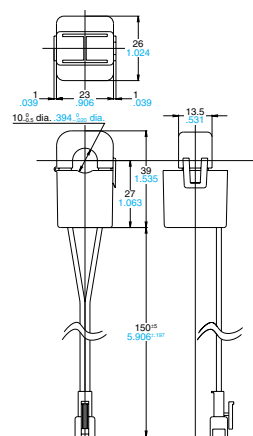

Recommended Commercial CT

Clamp-on type CT (U.R.D. co., Ltd.)

Rated current	Part number	d dia.	D dia.	W1	W2
100A	CTL-24CL-100A/1A-C2	24	70	43	41
200A	CTL-24CL-200A/1A-C2	24	70	43	41
300A	CTL-36CL-300A/1A-C2	36	90	53	51
400A	CTL-36CL-400A/1A-C2	36	90	53	51
500A	CTL-60CL-500A/1A-C2	60	115	65	62

For details, please see the U.R.D. co., Ltd. web site at <http://www.u-rd.com/>.

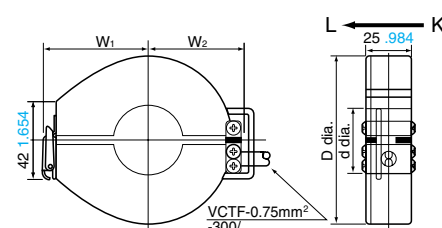

KW4S(AKW4)

SPECIFICATIONS

1. Main unit

Item	Specifications
Rated operating voltage	100 to 120/200 to 240V AC
Rated frequency	50/60 Hz common
Rated power consumption	Max. 10 VA
Allowable operating voltage range	85 to 132/170 to 264V AC (85% to 110% of rated operating voltage)
Allowable power off time	10ms
Ambient temperature	-10°C to +50°C +14°F to 122°F (Storage temperature: -25°C to +70°C -13°F to 158°F)
Ambient humidity	30 to 85%RH (at 20°C non-condensing)
Breakdown voltage (initial value)	Between insulated circuits: 2,000V/1 min. Note: Cut-off current: 10 mA However, protection varistors excluded
Insulation resistance (initial value)	Between insulated circuits: At least 100MΩ (With 500 V DC)
Vibration resistance (Functional)	10 to 55 Hz: 1 cycle/ min single amplitude of 0.35 mm .014 inch (10 min on 3 axes)
Vibration resistance (Destructive)	10 to 55 Hz: 1 cycle/ min single amplitude of 0.75 mm .030 inch (1 h on 3 axes)
Shock resistance (Functional)	Min. 98 m 321.522 ft./s ² (4 times on 3 axes)
Shock resistance (Destructive)	Min. 294 m 964.567 ft./s ² (5 times on 3 axes)
Power failure memory method	EEP-ROM (Over 100,000 overwrites)
Protective construction	IP66 (front panel with rubber gasket) Note: Water resistance (IP66) will be degraded by repeated installation (with contact).

2. Input

Item	Specifications		
Measuring item	Power	Integrated electrical energy (kWh)	
	Voltage	Effective value (V)	
	Current	Effective value (A)	
	Electricity charge	Integrated electricity charge (¥, \$, €)	
Phase and wire system	Single-phase two-wire system Single-phase three-wire system Three-phase three-wire system		
Input voltage	Rating	Single-phase two-wire system: 100 to 120/200 to 240V AC (common use) Single-phase three-wire system: 100 to 120V AC Three-phase three-wire system: 200 to 240V AC	
	Allowable measuring voltage	85% to 110% of rated operating voltage Single-phase two-wire system: 85 to 132/170 to 264V AC (common use) Single-phase three-wire system: 85 to 132V AC Three-phase three-wire system: 170 to 264V AC	
Input current	Rating of primary side	Dedicated CT	50 A (applied to dedicated CT only) (Gurantee accuracy range: 10% to 100% of a rated current)*
		Commercial CT	100 to 950 A (can be set via CT ratio) (Gurantee accuracy range: 10% to 100% of a rated current of each CT)*
	Rating of secondary side	Dedicated CT	16.7mA
		Commercial CT	1A
	Max. measuring current	Allowable current	120% of rated current of each CT (at 20°C)
Allowable measuring integrated electrical energy	999.9A	0 to 99999.9kWh	
Allowable measuring electricity charge	Yen: 0 to 999999¥ Dollars: 0 to 9999.99\$ Euros: 0 to 9999.99€		
Accuracy (Not including CT error)	Basic accuracy		Gurantee accuracy range: 10% to 100% of a rated current of each CT Integrated electrical energy: ±2.5%F.S. ±1 degit. (at 20°C rated input, rated frequency, power factor: 1) Voltage: ±2.5%F.S. ±1 degit (at 20°C rated input, rated frequency, power factor: 1) Current: ±2.5%F.S. ±1 degit (at 20°C rated input, rated frequency, power factor: 1) Electricity charge: ±2.5%F.S. ±1 degit (at 20°C rated input, rated frequency, power factor: 1)
		Temperature characteristics	±1.5% F.S./10°C ±1 degit (for -10 to 50°C range and rated input; based on 20°C, power factor: 1)
		Frequency characteristics	±1.5% F.S. ±1 degit (for ±5% frequency change and rated input; based on rated frequency, power factor: 1)

Note: * Please use within the range of accuracy guarantee of current of CT.

When you use with the primary side current out of accuracy guarantee range, an actual primary side current value may differ from the value of the display.

ex) The display may not be 0.0A at the time of primary side current 0A.

3. Pulse output for integrated electrical energy (transistor output)

Item	Specifications
Number of output points	1point
Insulation method	Optical coupler
Output type	Open collector
Output capacity	100mA 30V DC
Pulse width	Approx. 100ms*1
ON state voltage drop	1.5V or less
OFF state leakage current	100μA or less
Pulse output unit	0.001kWh, 0.01kWh, 0.1kWh, 1kWh, 10kWh, 100kWh (Setting modes can be set using the keys on the front panel.)

*1. Erroneous count can happen depending on the connected counter and PLC when the off time is short in the pulse output. Therefore, please change to a suitable pulse output unit.

4. Communication

1) Communication specifications

Item	Specifications	
Interface	Conforming to RS485	
Protocol	Our method/MEWTOCOL (Setting modes can be set using the keys on the front panel.)	
Isolation status	Isolated with internal circuit	
No. of connected units (Max.)	99 units**2*/31 units*3	
Transmission distance	1,200m	
Transmission speed (Baud rate)	2,400, 4,800, 9,600, 19,200 bps (Setting modes can be set using the keys on the front panel.)	
Transmission data format	Data length	7-bit/8-bit (Setting modes can be set using the keys on the front panel.)
	Parity	Not available/Odd/Even (Setting modes can be set using the keys on the front panel.)
	Stop bit	1 bit (Fix)
Communication method	Half duplex	
Synchronous method	Start-stop synchronous method	
Terminating resistor	Approx. 120Ω (internal)*1	

2) Factory settings

Transmission speed	Data length	Parity	Stop bit	Station No.
19,200 bps	8-bit	Not available	1 bit (Fix)	1

Notes:

- *1. Use only for a terminal station. Please refer to "4) RS485 wiring and terminal station setting" before setting it to the terminal station side. It is on the general station side when shipped.
- *2. We recommend Lineeye Co., Ltd. SI-35 as the PC side RS485 device.
- *3. Up to 99 units can be connected when an SI-35 or our recommended PLC are used. When devices other than these are mixed, the maximum number of connectable units is restricted to 31.

3) Recommended cable for RS485 communication

Please use the transmission cables in the table below for Eco-POWER METER's RS485 communication system.

Cable	Conductor		Insulator		Cable diameter	Example of equivalent cable
	Size	Resistance (at 20°C)	Material	Thickness		
Twisted-pair cable with shield	1.25mm ² (AWG 16) or more	Max. 16.8Ω/km	Polyethylene	Max. 0.5mm .020 inch	Approx. 8.5mm .335 inch	9860 made by Belden Inc.
	0.5mm ² (AWG 20) or more	Max. 33.4Ω/km	Polyethylene	Max. 0.5mm .020 inch	Approx. 7.8mm .307 inch	9207 made by Belden Inc.
VCTF	0.75mm ² (AWG 18) or more	Max. 25.1Ω/km	Polyvinylchloride	Max. 0.6mm .024 inch	Approx. 6.6mm .260 inch	VCTF0.75mm ² × 2C

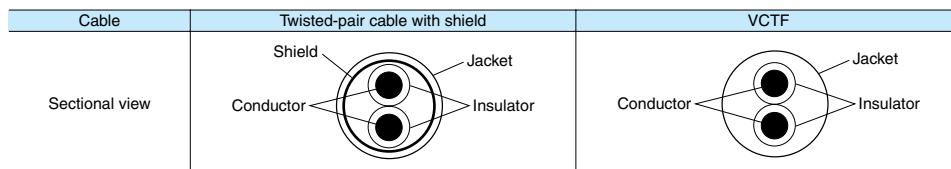

- Notes:
1. The twisted-pair cables must be shielded type.
 2. Use transmission cables of the same type. Do not use different types together.
 3. The twisted-pair cables with shield are recommended where electrical noises might occur.

4) RS485 wiring and terminal station setting

(1) Always be sure to set up a terminal station on Eco-POWER METER's RS485 system (Fig. 1).

(2) If using a shielded cable for the RS485 transmission line, ground one end. Use a class D (class 3) dedicated earth for grounding. Do not use the earth together with other earth wires (Fig. 1).

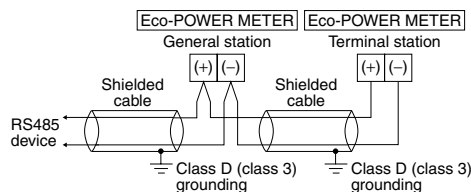

Fig.1

(3) Change the slide switch on the side of Eco-POWER METER as a terminal station (Fig. 2).

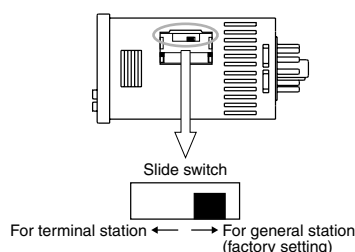

Fig.2

(4) Be sure to daisy chain the RS485 transmission line between each station. Do not use a splitter (Fig. 3).

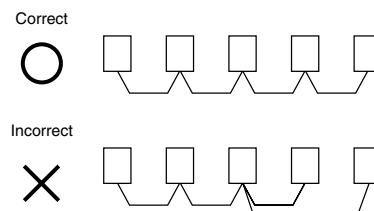
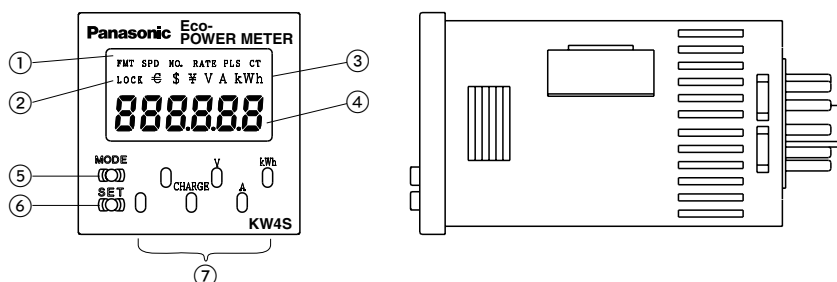

Fig.3

APPLICABLE STANDARDS

Safety standards	EN61010-1	Degree of pollution 2/Overvoltage category II
EMC	(EMI) EN61326	EN55011 Group 1 Class A
	Radiated emission electric field strength	EN55011 Group 1 Class A
	Noise terminal voltage	
	(EMS) EN61326	EN61000-4-2 4 kV contact
	Static discharge immunity	8 kV air
	RF electromagnetic field immunity	EN61000-4-3 10 V/m (80 MHz to 1 GHz)
		3 V/m (1.44 GHz to 2 GHz)
	EFT/B immunity	1 V/m (2.0 GHz to 2.7 GHz)
	Surge immunity	EN61000-4-4 2 kV (Power line)
	Conductivity noise immunity	1 kV (Signal line)
Power frequency electric field immunity	EN61000-4-5 1 kV (Power line)	
Immunity to voltage dips, momentary power stoppage and voltage fluctuations	EN61000-4-6 3 V/m (0.15 MHz to 80 MHz)	
	EN61000-4-8 30 A/m (50 Hz)	
	EN61000-4-11 10 ms, 30% (Rated voltage)	
	500 ms, Min. 90% (Rated voltage)	

PART NAME



- 1 Mode indicator
- 2 Lock indicator
- 3 Unit indicator

- 4 Display of integrated electrical energy, current, voltage, electricity charge and each setting value.

- 5 MODE key
Use to shift between setting modes
- 6 SET key
Perform each setting

- 7 Select key (No. 1 to No. 6)
Change each display item.
Use to shift between setting modes.

KW4S(AKW4)

DIMENSIONS

mm inch General tolerance: $\pm 1.0 \pm 0.09$

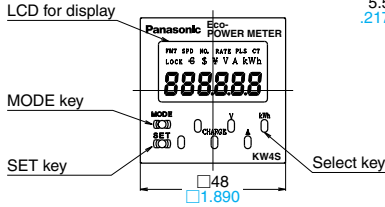
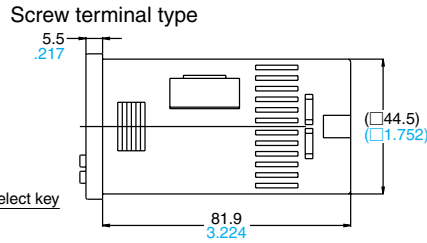
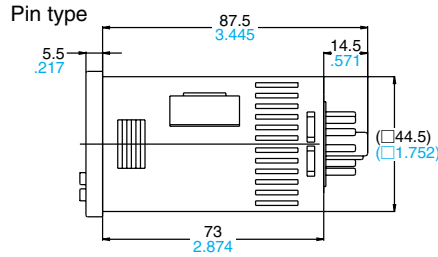

Dimensions for flush mount (with adapter installed)

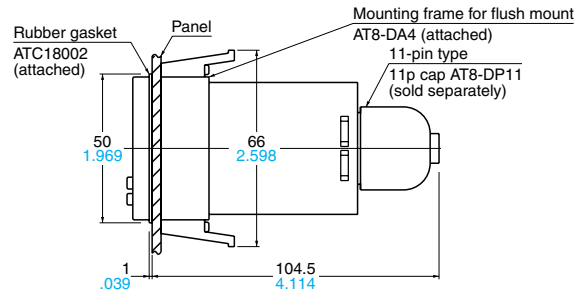

Dimensions for front panel installations

Panel cut-out dimensions

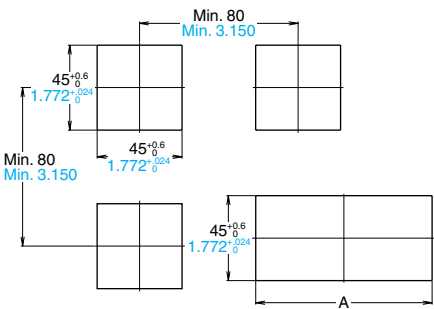

Front panel installations

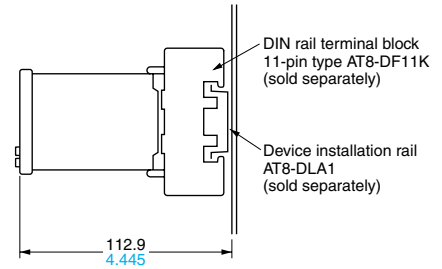
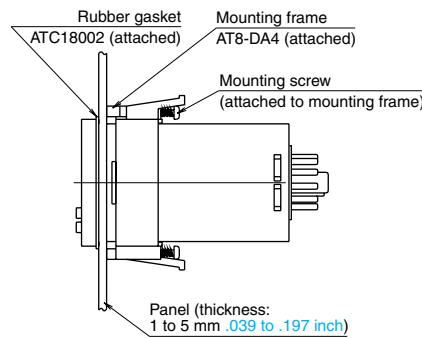

When n units are continuously installed, the dimension (A) is calculated according to the following formula (n: the number of units to be installed):
 $A = (48 \times n - 2.5) \times 0.6$ $A = (1.890 \times n - .098) \times 0.24$

Note: Installed continuously, waterproofing property on the unit will be lost.

TERMINAL LAYOUTS & WIRING DIAGRAMS

Single-phase two-wire system

When measuring with a single-phase two-wire system, one current transformer (CT) is required.

Single-phase three-wire system

When measuring with a single-phase three-wire system, two current transformers (CT) are required.

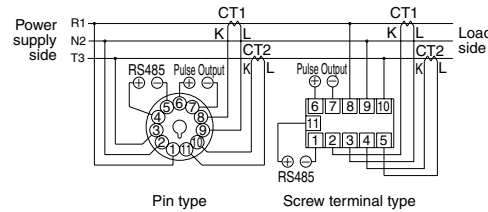
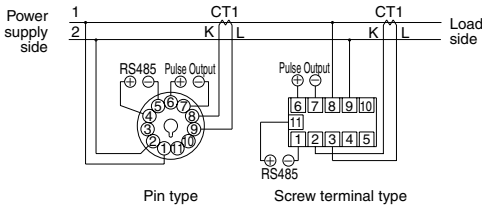

Three-phase three-wire system

When measuring with a three-phase three-wire system, two current transformers (CT) are required.

Terminal layouts

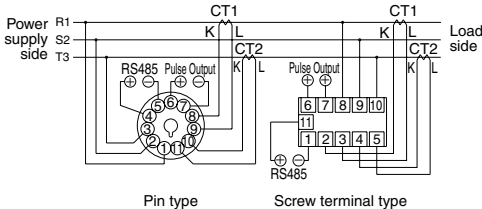

No.	Type	
	Pin type	Screw terminal type
1	1, R, R	RS485 -
2	2, N, S	CT1 K
3	3, T, T	CT1 L
4	RS485 +	CT2 K
5	RS485 -	CT2 L
6	Pulse output +	Pulse output +
7	Pulse output -	Pulse output -
8	CT1 K	1, R, R
9	CT1 L	2, N, S
10	CT2 K	3, T, T
11	CT2 L	RS485 +

You must connect in accordance with the wiring diagram. The voltages for input between each pin (terminal) are given in the table below.

System	Type	Pin number	Input voltage
Single-phase three-wire system	Pin type	① - ②	100 to 120/200 to 240 V AC (100 to 120/200 to 240 V ~)
	Screw terminal type	⑥ - ⑩	
Single-phase three-wire system	Pin type	① - ② - ③	100 to 120 V AC (100 to 120 V ~: 3 W)
	Screw terminal type	⑥ - ⑦ - ⑩	
Three-phase three-wire system	Pin type	① - ② - ③	200 to 240 V AC (200 to 240 V 3 ~)
	Screw terminal type	⑥ - ⑦ - ⑩	

Notes: 1. For safety and to protect the device, connect a breaker at the voltage input part.
 2. After wiring, turn the power off and on again (ON → OFF → ON).

CURRENT TRANSFORMER (CT) INSTALLATION

1) When installing a current transformer (CT), you must first connect the CT secondary side to the Eco-POWER METER and then wire the CT primary side to the load line.

2) The current transformer has polarity. Align with the direction (K → L) written on the current transformer (CT) and install from the power supply side facing the load side. Measurement is not possible if the direction is wrong.

3) On the dedicated current transformer (CT) (AKW4801), "K" is white and "L" is black.

4) Check beforehand that the power line thickness is smaller than the diameter of the through-hole of the current transformer (CT). When installing a clamp-on type CT, verify that the separating surfaces are making perfect contact when the CT is closed. Measurement errors will occur if there is a gap in the separating surfaces.

5) The length of the cable for the dedicated current transformer (CT) (AKW4801) is approximately 1 m. Extension of the cable is possible up to approximately 10 m if the environment is completely free from noise such as external and line induction noise, and the cable has a thickness of at least 0.75 mm². When extending the cable, use as thick a cable as possible.

*When extending the cable, please perform testing under actual conditions before using.

EACH MEASURED VALUE DISPLAY

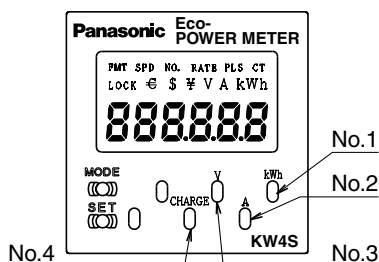

- Select key 1 → Integrated electrical energy display
- Select key 2 → Current display
- Select key 3 → Voltage display
- Select key 4 → Electricity charge display

1. Integrated electrical energy display

It is the mode which displays integrated electrical energy by present. Press Select key 1 to display the integrated electrical energy.

Sample display for integrated electrical energy: 65,432.1 kWh

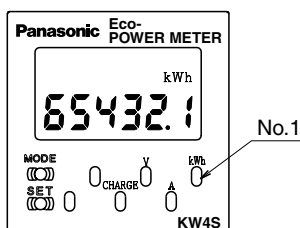

2. Current display

It is the mode which displays the current value of the load. Press Select key 2 to display the current.

Sample display for current: 15.8 A

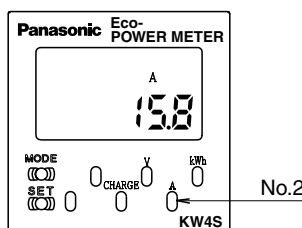

3. Voltage display

It is the mode which displays the voltage value of the load. Press Select key 3 to display the voltage.

Sample display for voltage: 201.8 V

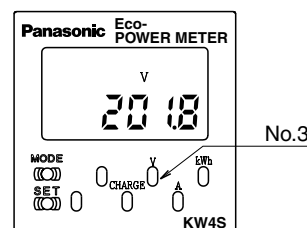

While displaying the integrated electrical energy, press MODE key while holding down SET key to clear this value.

* After reaching the full scale (99999.9 kWh), the value reverts to 0.0 kWh, and continues to measure.

4. Electricity charge display

It is the mode which displays the value of a standard of the electricity charge to the integrated electrical energy. Press Select key 4 to display the electricity charge.

By pressing Select key 4 at the electricity charge display, you can switch among ¥ (yen) \$ (dollar) and € (Euro). (¥ → \$ → €)

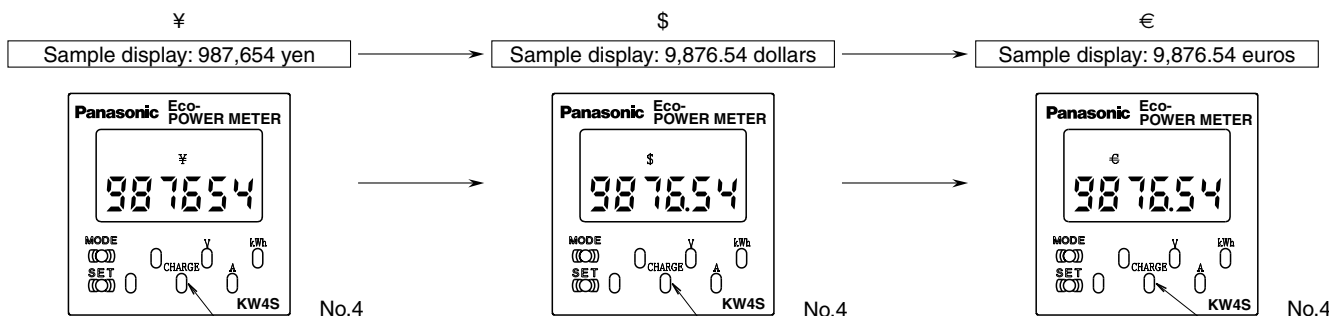

KW4S(AKW4)

OPERATION MODE *Set each operation mode before using.

1. Commercial CT ratio setting mode (AKW4121, AKW4221 only)

This mode is used to set the CT ratio of a commercial CT (commercially available current transformer (CT) with secondary side rating current of 1 A).

If your commercial CT is 100 A/1A, the CT ratio is 100.

1) Press MODE key. The mode indicator lights up fully.

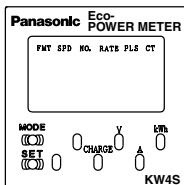

2) Press Select key 1. The [CT] indicator flashes, and the unit shifts to commercial CT ratio setting mode.

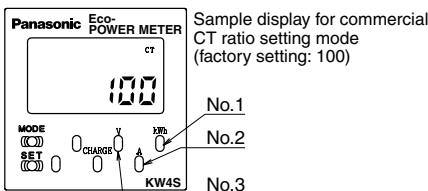

3) Enter the CT ratio using Select keys 1, 2, and 3.

* The CT ratio changes in increments of 50 and range from 100 and 950.

4) Press SET key to finalize the CT ratio setting, and return to the display previous to the mode setting display. The mode indicator light goes off.

* The dedicated CT type (AKW4111 and AKW4211) does not have a CT ratio setting mode.

2. Unit for pulse output setting mode

It is the mode which sets up the unit of a pulse output. A pulse is outputted whenever the amount of integrated electricity charge reaches per setup.

1) Press MODE key. The mode indicator lights up fully.

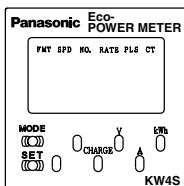

2) Press Select key 2. The [PLS] indicator flashes, and the unit shifts to unit for pulse output setting mode.

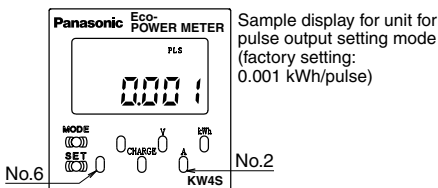

3) Press Select key 6 to change the unit for pulse output.

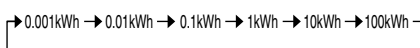

4) Press SET key to finalize the unit for pulse output, and return to the display previous to the mode setting display. The mode indicator light goes off.

3. Electricity rate setting mode

It is the mode which sets up the electricity rate used as a standard per 1 kWh.

1) Press MODE key. The mode indicator lights up fully.

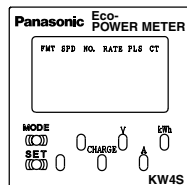

2) Press Select key 3. The [RATE] indicator flashes, and the unit shifts to electricity rate setting mode.

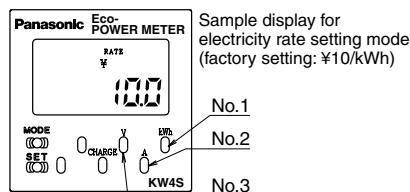

3) Press Select key 6 to change between ¥ (yen), \$ (dollars), and € (euros).

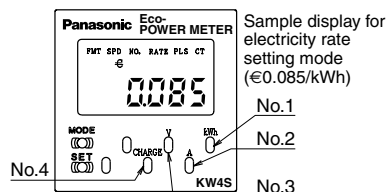
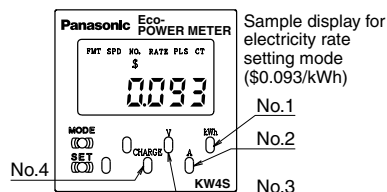
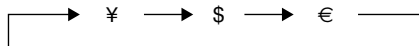

4) Set rate per 1 kWh by pressing Select keys 1, 2, 3, and 4.

For electricity rate per 1 kWh;

- ¥ (Yen) can be set in the range of 0.0 to 99.9.
- \$ (Dollar) can be set in the range of 0.000 to 9.999.
- € (Euro) can be set in the range of 0.000 to 9.999.

5) Press SET key to finalize the electricity rate per 1 kWh, and return to the display previous to the mode setting display. The mode indicator light goes off.

4. Station number setting mode (RS485)

It is the mode which sets an individual station number for each main unit when communicating by connecting two or more main units in serial communication (RS485). When setting make sure that the station numbers do not overlap.

1) Press MODE key. The mode indicator lights up fully.

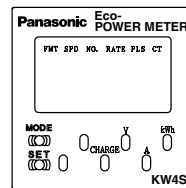

2) Press Select key 4. The [NO.] indicator flashes, and the unit shifts to station number setting mode.

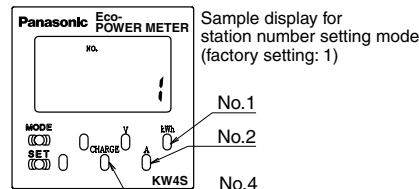

3) Enter the station number using Select keys 1 and 2.

* The station number can be set between 1 and 31.

4) Press SET key to finalize the station number setting, and return to the display previous to the mode setting display. The mode indicator light goes off.

5. Transmission speed setting mode (RS485)

It is the mode which sets up transmission speed in serial communication (RS485). Please set up transmission speed according to the masters (PC etc.).

1) Press MODE key. The mode indicator lights up fully.

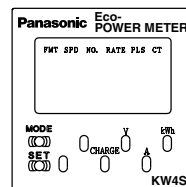

2) Press Select key 5. The [SPD] indicator flashes, and the unit shifts to transmission speed setting mode.

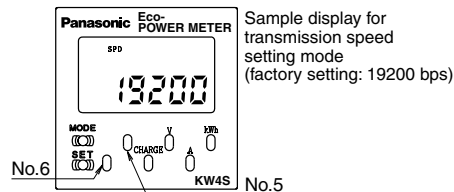

3) Press Select key 6 to change the transmission speed.

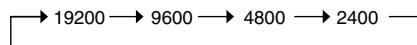

4) Press SET key to finalize the transmission speed setting, and return to the display previous to the mode setting display. The mode indicator light goes off.

6. Transmission format setting mode (RS485)

It is the mode which sets up a transmission format in serial communication (RS485). Please set up transmission format according to the masters (PC etc.).

1) Press MODE key. The mode indicator lights up fully.

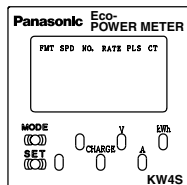

2) Press Select key 6. The [FMT] indicator flashes, and the unit shifts to protocol setting mode.

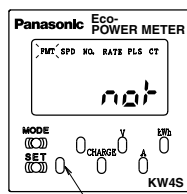

Sample display for protocol setting mode (MEW system example)

No.6

3) Press Select key 6 to change the protocol system.



4) When the SET key is pressed, the currently displayed communication protocol is set and the screen moves to the mode for setting the data length and parity.

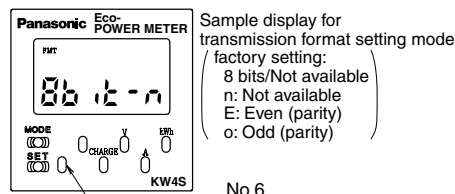

Sample display for transmission format setting mode (factory setting: 8 bits/Not available n: Not available E: Even (parity) o: Odd (parity))

No.6

5) Press Select key 6 to change the data length/parity.

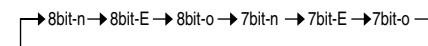

6) Press SET key to finalize the data length/parity setting, and return to the display previous to the mode setting display. The mode indicator light goes off.

7. Lock mode setting

When you press SET key continuously for about three seconds, the [LOCK] indicator lights, and MODE key and Select keys become locked (pressing them will have no effect).

Press SET key continuously for about three seconds again to release Lock mode. The [LOCK] indicator goes off, and the Lock mode is released (unlocked).

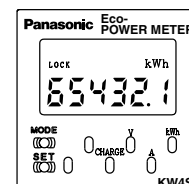

TO SHIFT MODE SETTINGS

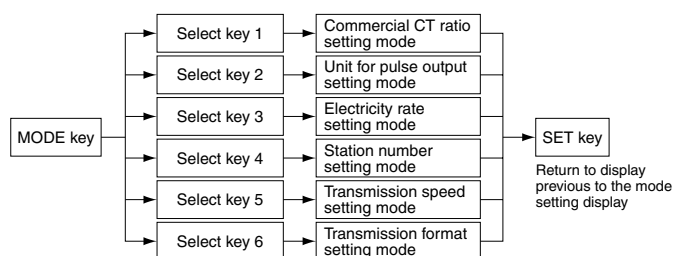

SELF-DIAGNOSIS FUNCTION

If an error occurs, one of the following indications will appear.

Display	Meaning	Output status	Recovery	The value after recovery
Err-00	CPU error	OFF	Power turned on again	The value when power on before the error occurs
Err-01	Memory error. See note		E2P-ROM lifetime ended. Replace unit.	—

Note: * Includes the possibility that the E2P-ROM's life has expired.

POWER-FAILURE MEMORY

Eco-POWER METER stores integrated electrical energy, electricity charge, and each of its settings in E2P-ROM until the power is shut off (power-failure guarantee). For this reason, you should avoid using the unit in an environment where the power is turned on and off very frequently, if possible. Utilization in such an environment will shorten the lifetime of the E2P-ROM.

OPTIONS

Product Name	Part No.
DIN rail terminal socket	AT8-DF11K
Rear terminal socket	AT78051
DIN protective cover (flexible)	AQM4803

OTHERS

Eco-POWER METER is designed chiefly for managing energy saving. It is not intended to be used for billing. Also note that this is not a specific meter that pass the official approval by the designated organization, which sets to Measurement Law, so it cannot be used for proof of electrical energy.

SURGES

1. If the power supply surge exceeds the following value, the internal circuit could be destroyed, so be sure to use a surge absorption element.

Surge voltage: 6,000V

Standard surge waveform

The values in the graph right are the surge-voltage resistance at $\pm(1.2 \times 50)$ μ s of single-polarity full-wave voltage.

Surge wave form

$\pm(1.2 \times 50)$ μ s uni-polar full wave voltage

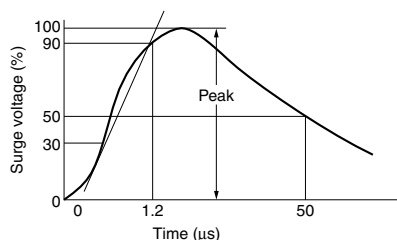

2. External noise of up to the level shown below is treated as noise voltage, but levels higher than this could lead to malfunctioning or damage to the internal circuit.

	Power supply terminals	Input terminals
Noise voltage	1,500V	500V

Noise wave form (noise simulator)

Rise time: 1ns

Pulse width: 1 μ s, 50 ns

Polarity: \pm

Cycle: 10ms

NOTES

1. Avoid locations subject to flammable or corrosive gases, excessive dust, oil, vibrations, or excessive shocks.

2. Since the cover is made of polycarbonate resin, avoid contact with or use in environments containing methyl

alcohol, benzene, thinners, and other organic solvents; and ammonia, caustic sodas, and other alkaline substances.