



Read this document carefully before using this device. The guarantee will be expired by damaging of the device if you don't attend to the directions in the user manual. Also we don't accept any compensations for personal injury, material damage or capital disadvantages.

ENDA EPDA1 / EPAA1 Panel Mountable Solid State Relays

Thank you for choosing ENDA EPDA1 / EPAA1 series Solid State Relays

- * 25-40-50-70-100-120A AC load current.
- * 280-420V AC load voltage.
- * 8-30V AC/DC or 90-240V AC input voltage.
- * LED status indicator for input voltage.
- * Zero-cross switching.
- * Applicable for three phase loads.
- * Built-in varistor protection.
- * Panel mountable.
- * CE marked according to European Norms .

ORDER CODE

Product Basic Code		EP	D	A	1	-	2	25	Z	
Panel type SSR		EP								
Input voltage		8-30V AC/DC		D						
		90-240V AC		A						
Load voltage		AC		A						
Pole number		Single-pole		1						
Switching		Zero crossing		Z						
Load current		25A AC		25	40A AC		40	50A AC		50
		70A AC		70	100A AC		100	120A AC		120
Load voltage		24-280V AC		2	50-420V AC		4			

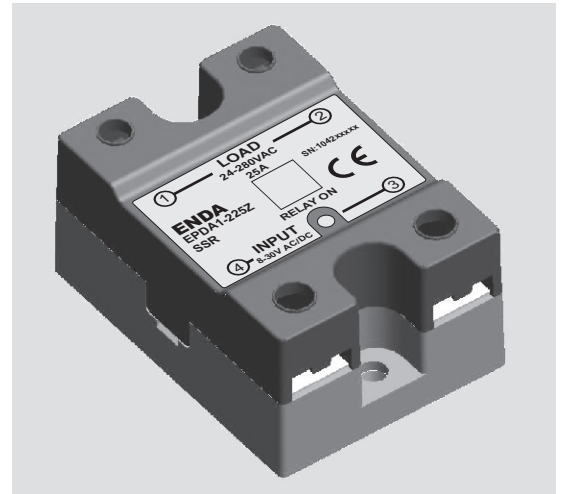

ENVIRONMENTAL CONDITIONS	
Ambient-storage temperature	-25... +60 °C / -30... +100 °C (In the environment icing and condensation should not be.)
Relative humidity	At +40° C %50, temperature was reduced at +20°C could be %90 . (Condensation should not be.)
Pollution degree	2
Overvoltage category	II
Altitude	Max. 1000m
Protection	IP20 According to EN60529

Do not use the device in locations subject to corrosive and flammable gases.

OUTPUT								
Order code	EPxA1-225Z	EPxA1-240Z	EPxA1-425Z	EPxA1-440Z	EPxA1-450Z	EPxA1-470Z	EPxA1-4100Z	EPxA1-4120Z
Load current, AC51/25°C (Arms)	25	40	25	40	50	70	100	120
Load voltage (Vrms)	24 - 280		50 - 420					
Overload current t=1s/25°C (Arms)	85	150	70	110	150	360	540	720
Non rep. surge current/25°C (Arms)	250	400	190	290	380	900	1350	1800
On-state voltage drop (Vrms)	1,6		1,8		1,8			
Leakage current (mArms)	5		8		10	15	20	20
I ² t For fusing t=10ms (A ² s)	340	880	265	610	720	4000	9100	16200
Frequency (Hz)	50 - 60		50 - 60		50 - 60			
Minimum operating current (mArms)	160		200		300	400	500	500

THERMAL SPECIFICATIONS								
T _j Junction temperature (°C)	125	125	125	125	125	125	125	125
R _{th(j-c)} Junction-case thermal resistance (°C/W)	1,0	1,0	1,2	1,0	0,6	0,4	0,3	0,25
R _{th(j-a)} Junction-ambient thermal resistance (°C/W)	20	20	20	20	20	20	20	20

INPUT		
Order code	EPDA1-xxxZ	EPAA1-xxxZ
Input voltage	8 - 30Vac/dc	90 - 240Vac
Pick-up voltage	> 6Vac/dc	> 75Vac
Drop-out voltage	< 2Vac/dc	< 6Vac
Input current	< 17mAac/10mAdc	< 8mAac
Turn-on time	Maximum ½ Period	Maximum 1 Period
Turn-off time	Maximum ½ Period	Maximum 2 Period
LED indicator	If the input voltage >6V ac/dc, LED lights up.	If the input voltage >75V ac, LED lights up.

GENERAL	
Order code	EPxA1-xxxZ
Dimensions	W45xH62xD31mm
Weight	For EPxA1-2xx/4xxZ 95g , For EPxA1-550/570Z 110g , For EPxA1-5100/5120Z 115g (After packaging)
Isolation voltage	2500Vrms between I/O terminals for 1 min.
Connection	For power line 16mm ² (with cable terminal 25mm ²) cable, for signal line 4mm ² cable can be connected.
Terminal screw torque	For power line max. 2,2Nm, for signal line max. 1,2Nm.
Product standard	EN 60947-4-3
Mounting	With M4 screws is mounted to the panel.
Enclosure material	Self extinguishing plastics (. (According to EN 60695-11-10 V-O)

While cleaning the device, solvents (thinner, benzene, acid etc.) or corrosive materials must not be used.

DIMENSIONS

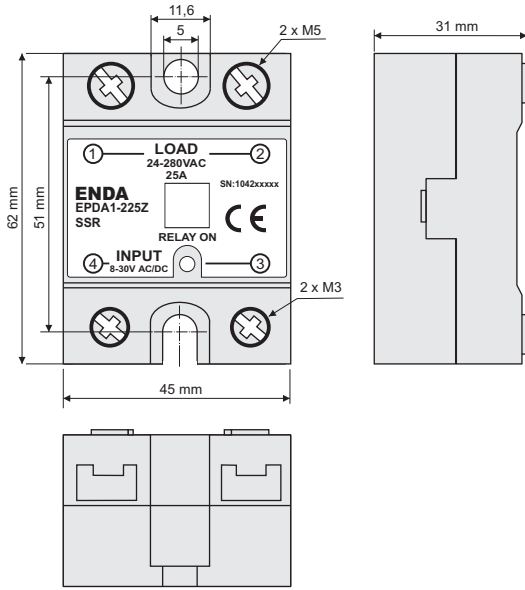

CONNECTION DIAGRAM

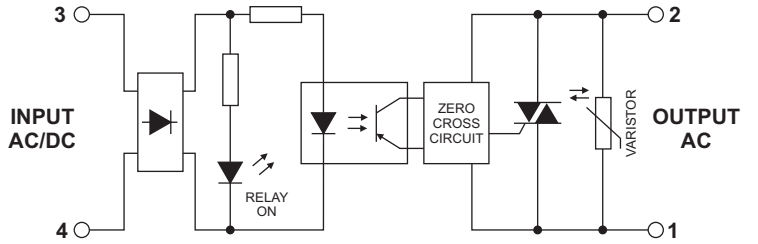
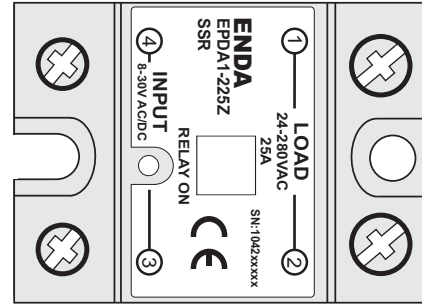

HEATSINKS

ETS-46-62 HEATSINK

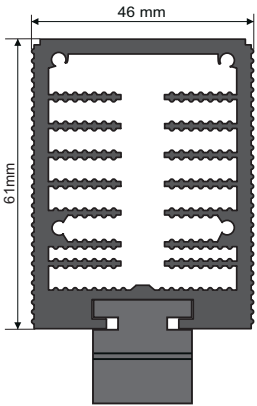

24V DC FAN

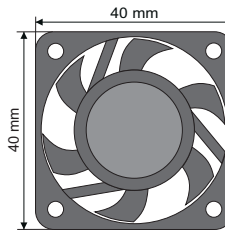

Supply : 24V DC
Current: 100mA

Aluminium Heatsink	Dimensions (mm)	Thermal Resistance (°C/W)
ETS-46-62	46x61x62	2,4
ETS-46-80	46x61x80	2,0
ETS-46-100	46x61x100	1,6
ETS-46-62 Fan ile	46x61x72	1,7
ETS-46-80 Fan ile	46x61x90	1,4
ETS-46-100 Fan ile	46x61x110	1,0

The fan must be mounted to it so that the low part of the cooler. Airflow must be to the cooler.

CONNECTION EXAMPLES

Single Phase Load Application

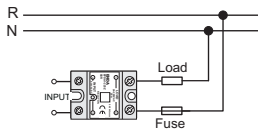

Three Phase Load Application With The Two SSRs

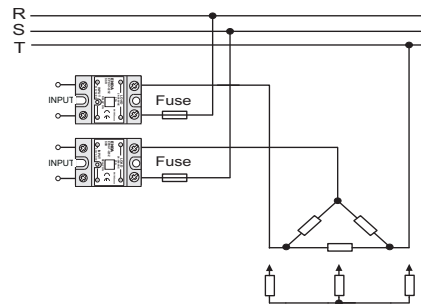

Three Phase Load Application With Three SSRs

